

# Locked Air® | LOCKED™ PAPER

Sustainable Protective Packaging Solutions







## ABOUT BJT

BJT is an advanced manufacturer of sustainable protective packaging machines and consumables. Our worldwide brand, LockedAir, specializes in inflatable packaging solutions, while LockedPaper focuses on paper-based protective packaging solutions.

With over 10 years of dedication to protective packaging innovation, we have experienced significant growth, offering a comprehensive range of machines, consumables, and integrated solutions for both paper and inflatable packaging. We have become the preferred choice in more than 52 countries.

We serve a diverse range of customers, from large 3PL fulfillment centers with over 200,000 packages processed per day to small businesses packaging as few as 10 packages daily. Our commitment to sustainability and automation sets us apart, delivering unique value to our customers.

- Recycled/Bio sustainable material film, paper based inflatable film and paper.
- Reliable, full range, advanced machines with automated solutions.
- Localized professional service and customized support.



# Our solutions of sustainable

**Locked Air**®

Air Pillow  
LA-E5P



Air Bubble  
LA-F2



Air Cushion Pillow & Bubble  
LA-E4S



Air Cushion Pillow & Bubble  
LA-E4C



**LOCKED**™  
PAPER

Paper Void Fill  
LP-V1



Paper Void Fill  
LP-F1



Paper Cushion Pad  
LP-C1



Paper Cushion Pad  
LP-C2



Paper Wrap  
LP-IB500C

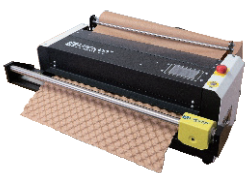

Paper Wrap  
LP-IB500Pro

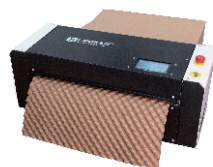

Paper Wrap  
LP-HA



Carton Sealing  
EG100



Paper Wrap  
Handex



Paper Wrap  
LP-H1S



Paper Void Fill  
LP-VM1



Paper Void Fill  
FlowFill



Carton Sealing  
MG80

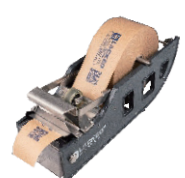





Scan for video

# LA-E5P

## Industrial class air pillow system



- Heavy duty industrial design, support 7\*24h peak season.
- Up to 98 ft/min, ensure high productivity.
- No blade and Teflon belt design, maintenance free.
- Max length of 7872ft per Roll\*, minimize the change over cycle. \*0.4mil.
- Strong sealing of ultra low defect rate, reduce waste.



PN code	Description	Speed (ft/min)	Machine Size (inch)	Machine Weight (LBS)
60A01153	Industrial Class Air pillow machine	98	15x15x14	42

## Configurations

Model	EC2007-G-S-S	ET1009
PN code	60A06010	60A10010
Description	Mobile basket	Simple piping system
Max. film width(inch)	16	10
Dimension(LxWxH inch)	31.5x31.5x31.5	39x18.5x115
Weight(LBS)	70.5	209

## Film Options:

PN code	Model	Material	Thickness (mil)	Width (inch)	Perforation (inch)	Roll Length (ft)	Roll/Pallet
90R01243	MEY-H-08-8-4-L	HDPE	0.8	8	4	4790	96
90R01248	MEY-RH30-05-8-5-L	30% Recycled HDPE	0.5	8	5	5902	96
90R01264	MEY-RH30-05-8-8-L	30% Recycled HDPE	0.5	8	8	5902	96





Scan for video

# LA-F2

## Industrial class air bubble system





- Ultra High Inflation level, maximum the protection.
- Up to 82 ft/min high-speed, enhance the productivity.
- 16-32 inch width film applied, universal for applications.
- Strong and durable sealing.
- Build in air pump, smaller footprint with less noise, easy to set up.



PN code	Description	Speed (ft/min)	Machine Size (inch)	Machine Weight (LBS)
60A01131	Industrial Class Air bubble machine	82	18x23x20	48.5

## Configurations

Model	FR8002	FR8003
		
PN code	60A11002	60A11015
Description	Roll winder	Roll winder
Max. film width (inch)	32	32
Dimension(LxWxH inch)	Expand:52x19x31.5 Collapse:31.5x19x34	29x29x46
Weight (LBS)	86	88

## Film Options:

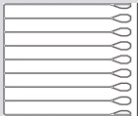
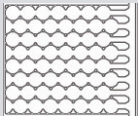
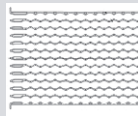
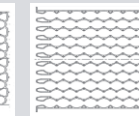
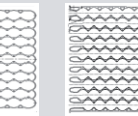
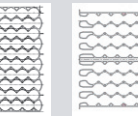
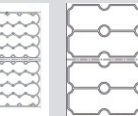
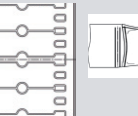
Series	MFA	MFB	MFB25	MFB32	MFB33	MFB40	MFC	MEX
Shape	Air tube	Ø1.7inch round bubbles	Ø1 inch round bubbles	Ø1.26 inch round bubbles	Ø1.3 inch round bubbles	Ø1.6 inch round bubbles	Air tube	Air pillow
Pattern								

PN code	Model	Material	Thickness (mil)	Width (inch)	Perforation (inch)	Roll Length (ft)	Roll/Pallet
90B01181	MFB-A-08-16-13-L	PA/PE	0.8	16	13	1969	120
90B01033	MFB-A-10-16-13-L	PA/PE	1.0	16	13	1476	120
90B01041	MFB-A-10-32-13-L	PA/PE	1.0	32	13	361	128
90B01232	MFB-A-14-16-6.5-L	PA/PE	1.4	16	6.5	1050	120
90B01080	MFB-A-14-16-13-L	PA/PE	1.4	16	13	1050	120
90B01183	MFB25-A-08-16-13-L	PA/PE	0.8	16	13	1969	120
90B01184	MFB25-A-10-16-13-L	PA/PE	1.0	16	13	1476	120



Scan for video

# LA-E4S

## Universal air cushion system



- Sustainable material option: biodegradable, up to 100% recycled and paper based.
- Automatic temperature adj. , and cooling design ensures strong sealing.
- Wrinkle-free seal, strong and durable.
- High inflation level.
- Versatile integration/accessory options.



ET1003	ET1005	ET1007	LT9002	ET400
--------	--------	--------	--------	-------

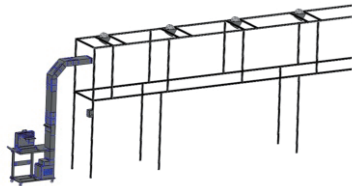

EC2005	EC2007	FR8002	FR8003	FR8004
--------	--------	--------	--------	--------



### Configurations:

PN code	Model	Description	Machine Size (inch)	Machine Weight (LBS)
60A10009	ET1003	Bubble film over head transmission system (widening pipe)	32x18.5xH	209
60A04004	ET1005	Multi-fan conveying system	Customized size	Customized
60A04018	ET1007	Integrated transmission system	31x33x110	Customized
60A04019	LT9002	Lifting system	19x16.5x41	66
60A04025 & 60A04024	ET400&Stand	Separator&Stand	36x20.2x65.3	101.5
60A04005	EC2005	Portable Bench	28x18x34	51
60A06009	EC2007	Mobile basket	47x31.5x35	70.5
60A11002	FR8002	Roll winder	Expand: 52x19x31.5 Collapse: 31.5x19x34	86
60A11015	FR8003	Roll winder	29x29x46	88
60A11009	FR8004	Roll winder	29x29x43	55



Model	LA-E4S	LA-E4S Paper	LA-E4C
			
PN code	60A01143	60A01148	60A01113
Description	Business class air cushion pillow & bubble machine	Paper air pillow & bubble machine	Starter class air cushion pillow & bubble machine
Film type	Air pillow, air bubble	Paper air pillow/bubble	Air pillow, air bubble
Max Film Width(inch)	32	16	16
Speed(ft/min)	59	59	26
Machine Size(inch)	14x12x13.6	14x12x13.6	14x12x13.6
Machine Weight(LBS)	20	20	20

## Film Options:

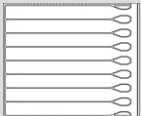
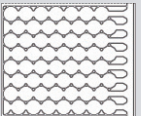
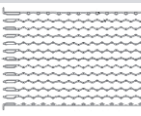
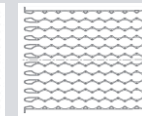
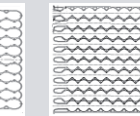
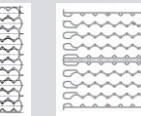
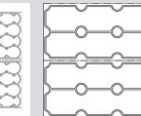
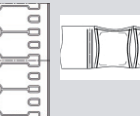
Series	MFA	MFB	MFB25	MFB32	MFB33	MFB40	MFC	MEX
Shape	Air tube	Ø1.7inch round bubbles	Ø1 inch round bubbles	Ø1.26 inch round bubbles	Ø1.3 inch round bubbles	Ø1.6 inch round bubbles	Air tube	Air pillow
Pattern								

PN code	Model	Material	Thickness (mil)	Width (inch)	Perforation (inch)	Roll Length (ft)	Roll/Pall	LA-E4S	LA-E4S Paper	LA-E4C
92R01005	MEX-KPB-30-8-5-C	Paper film	3.0	8	5	722	240		√	
90R01286	MEX-RH50-06-8-5-L	50% Recycled HDPE	0.6	8	5	2625	200	√		√
90R01287	MEX-RH50-06-8-8-L	50% Recycled HDPE	0.6	8	8	2625	200	√		√
90R01288	MEX-RL50-10-8-5-L	50% Recycled LDPE	1.0	8	5	1575	200	√		√
90B01181	MFB-A-08-16-13-L	PA/PE	0.8	16	13	1969	120	√		√
90B01033	MFB-A-10-16-13-L	PA/PE	1.0	16	13	1476	120	√		√
90B01041	MFB-A-10-32-13-L	PA/PE	1.0	32	13	361	128	√		
90B01232	MFB-A-14-16-6.5-L	PA/PE	1.4	16	16	1050	120	√		√
90B01080	MFB-A-14-16-13-L	PA/PE	1.4	16	13	1050	120	√		√
90B01183	MFB25-A-08-16-13-L	PA/PE	0.8	16	13	1969	120	√		√
90B01184	MFB25-A-10-16-13-L	PA/PE	1.0	16	13	1476	120	√		√
90B01008	MFB-H-08-16-13-L	HDPE	0.8	16	13	1476	120	√		√
90B01078	MFB-L-10-16-6.5-L	LDPE	1.0	16	6.5	1476	120	√		√
90B01031	MFB-L-10-16-13-L	LDPE	1.0	16	13	1476	120	√		√
90A01031	MFC-H-08-16-11-L	HDPE	0.8	16	11	1476	120	√		√
92A01002	MFC-KPB-30-16-5.5-C	Paper film	3.0	16	5.5	722	240		√	
90B01110	MFF-H-08-32-13.4-L	HDPE	0.8	32	13.4	361	128	√		√
90B01187	MFF-RH50-08-16-13.4-C	50% Recycled HDPE	0.8	16	13.4	1476	120	√		√



Scan for video

# LP-V1

## Paper void-fill system



- Dual-direction folded “V” shaped, fill more by less, 30% paper saving.
- Narrow paper width, easy to load.
- Bladeless design, safe and maintenance-free.
- One touch to clear jam, simple to maintain.



PN code	Description	Feed Speed (ft/min)	Machine Size (inch)	Machine Weight (LBS)
60A07029	Paper void-fill machine	147	26x21x(59-75)	37

Model	Floor Stand	Table Stand	Swivel arm Stand
PN code	14A03158	14A03185	14A03194
Height(inch)	59-75	35-43	36
Weight(LBS)	42	20	22

### Kraft Paper Options:

PN code	Model	Paper	Ply	CTN/Pallet	Basis Weight (#)	Length (ft)	Width (inch)	Perforation (inch)
90F01041	MPE-43-075	Eco	1	80	43	1640	7.5	3.7
90F01040	MPV-43-075	Virgin	1	80	43	1640	7.5	3.7
90F01039	MPV-30-075	Virgin	1	80	30	2296	7.5	3.7





Scan for video

# LP-F1

## Paper void-fill system



- Lower jam rate with jam self-clear design.
- Self sharpen blade, simple to maintain.
- Easy to load.



PN code	Description	Feed Speed (ft/min)	Machine Size (inch)	Machine Weight (LBS)
60A07047	Paper void-fill machine	394	26x27x(57-73)	42

Model	Floor Stand	Table Stand	Swivel arm Stand
			
PN code	14A03162	14A03186	14A03194
Height(inch)	57-73	34-42	39
Weight(LBS)	42	18	22

### Kraft Paper Options:

PN code	Model	Paper	Ply	CTN/Pallet	Basis Weight (#)	Length (ft)	Width (inch)	Perforation (inch)
90F01037	MPR-30-150	Recycled	1	60	30	1640	15	11
90F01045	MPV-30-150	Virgin	1	60	30	1640	15	11
90F01035	MPE-30-150	Eco	1	60	30	1640	15	11
90F01032	MPR-43-150	Recycled	1	60	43	1181	15	11
90F01036	MPV-43-150	Virgin	1	60	43	1181	15	11
90F01034	MPE-43-150	Eco	1	60	43	1181	15	11



Scan for video

# LP-C1



## Narrow paper cushion pad system

- Easy to load, fast startup.
- Low crimp loss, saving paper costs.
- Universal consumables to set up 1-ply or 2-ply.
- Double puncture locked pad, strong and reliable.
- Low jam rate, jam clear design.

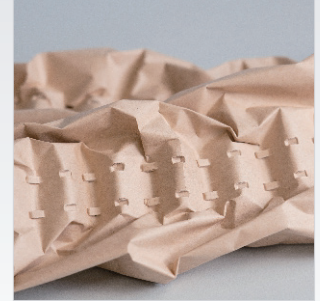

PN code	Description	Feed Speed (ft/min)	Cutting Speed (times/min)	Machine Size (inch)	Machine Weight (LBS)	Stand Weight (LBS)
60AC7008	Narrow paper cushion pad machine	118	80	21x44x55	99	61

### Kraft Paper Options:

PN code	Model	Paper	Ply	CTN/Pallet	Basis Weight (#)	Length (ft)	Width (inch)	Perforation (inch)
90F01036	MPV-43-150	Virgin	1	60	43	1181	15	11
90F01034	MPE-43-150	Eco	1	60	43	1181	15	11
90F01045&90F01035	MPV-30-150&MPE-30-150	Virgin&Eco	2	60	30&30	1640	15	11
90F01045&90F01045	MPV-30-150&MPV-30-150	Virgin&Virgin	2	60	30&30	1640	15	11
90F01034&90F01034	MPE-43-150&MPE-43-150	Eco&Eco	2	60	43&43	1181	15	11
90F01036&90F01036	MPV-43-150&MPV-43-150	Virgin&Virgin	2	60	43&43	1181	15	11



Scan for video

# LP-C2



## Wide paper cushion pad system

- Pre-folded fanfold paper, save space.

Under table bracket      Endless paper pad supply system



PN code	14A03220	60AC7017
Size including machine (inch)	33x22x12	63x39x65
Machine Weight (LBS)	35	123
Max. loading paper length (ft)	656/1181	24934

PN code	Description	Feed Speed (ft/min)	Cutting Speed (times/min)	Machine Size (inch)	Machine Weight (LBS)	Stand Weight (LBS)
60AC7010	Wide paper cushion pad machine	197	80	22x43x59	115	75

### Kraft Paper Options:

PN code	Model	Paper	Ply	CTN/Pallet	Basis Weight (#)	Length (ft)	Width (inch)	Perforation (inch)
90F01053	MPVV-43-43-300P	Virgin&Virgin	2	30	43/43	656	30	11
90F01054	MPRE-43-43-300P	Recycled&Eco	2	30	43/43	656	30	11
90F01056	MPVV-30-43-300P	Virgin&Virgin	2	30	30/43	755	30	11
90F01047	MPV-55-300P	Virgin	1	30	55	984	30	11
90F01050	MPE-43-300P	Eco	1	30	43	1181	30	11





Scan for video

# LP-IB500C/AC/Pro

## Embossed paper-bubble wrapping

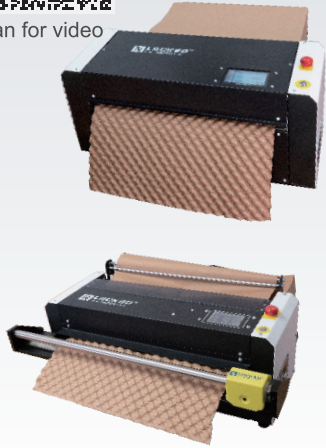

- Easy to load, simple training to start.
- Sturdy shaped paper bubbles, better protection.
- Jam free design, lower down time loss.
- Auto-tear without blade cutting, safe and maintenance-free \*(only for LP-IB500PRO).
- High speed up to 82 ft/min, excellent productivity \*(only for LP-IB500PRO).



Model	LP-IB500C	LP-IB500AC	LP-IB500 Pro
-------	-----------	------------	--------------

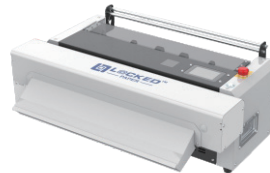
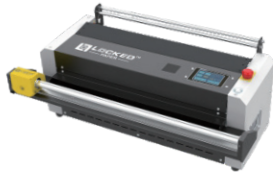

PN code	60AI7003	60AI7007	60AI7004
Speed(ft/min)	39	39	82
Machine Size(LxWxH)(inch)	15x11x12	27.5x19x11	26.5x11x12
Machine Weight(LBS)	71	84	88
Cut Mode	Manual Cutter	Auto-cutter	Auto-tear

## Kraft Paper Options:

PN code	Model	Ply	CTN/Pallet	Basis Weight (#)	Length (ft)	Width (inch)	Perforation (inch)
90F01029	MPS-49-118	1	96	49	1640	12	11
90F01030	MPS-49-197	1	94	49	1640	20	11



Scan for video

# LP-HA MC/AC

## Paper wrap and light load blocking system



- 2:1 high stretch ratio, maximizing the paper utilization.
- High speed up to 89 ft/min.
- Easy to load with automatic recentering design.
- Auto or manual cutting are available.
- Small footprint, easily integrated into existing pack stations.

Model	LP-HA MC	LP-HA AC
-------	----------	----------

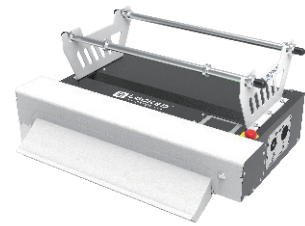

PN code	60AH7005	60AH7011
Description	Manual paper wrap and light load blocking machine	Electric paper wrap and light load blocking machine
Speed(ft/min)	—	89
Machine Size(inch)	25x19x13	27x22x13
Machine Weight(LBS)	66	79
Cut Mode	Manual Cutter	Auto-cutter

### Paper Options:

PN code	Model	Paper	Ply	CTN/Pallet	Basis Weight (#)	Length (ft)	Width (inch)
90E01001	HEX-49-197	Honeycomb	1	120	49	820	20
90N01003	INT-12-118	Interleaf	1	180	12	2756	12



Scan for video

# LP-H1/H1S/H1M

## Paper wrap and light load blocking system

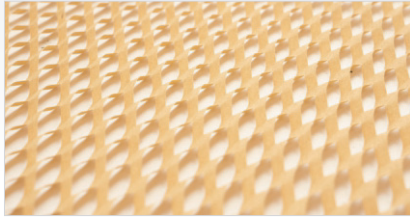

- Simple design supports quick assembly and easy loading.
- Paper tensile manually controlled, stretch the honeycomb paper on demand.
- Light weight and small footprint, ensures easy integration into any packaging station.
- Constant tension throughout the whole paper roll, no extra adjustment is needed in the middle.
- Affordable design, low cost.

Model	LP-H1	LP-H1S	LP-H1M
-------	-------	--------	--------



PN code	60A07009	60A07010	60A07012
Min Dia. of Honeycomb Roll Core (inch)	2	2	2
Min Dia. of Interleaf Roll Core (inch)	1.5	–	–
Max width of honeycomb paper(inch)	20	20	15
With interleaf paper?	√	–	–
Machine Size(LxWxH)(inch)	24x16x4	23x9x4	19x8x7
Machine Weight(LBS)	18	8	9

### Paper Options:

PN code	Model	Paper	Ply	CTN/Pallet	Basis Weight (#)	Length (ft)	Width (inch)	Applicable machine
90E01001	HEX-49-197	Honeycomb	1	120	49	820	20	LP-H1&H1S
90E01015	HEX-49-150	Honeycomb	1	150	49	820	15	LP-H1M
90E01002	INT-11-120	Interleaf	1	180	11	2756	12	LP-H1
90N01003	INT-12-120	Interleaf	1	180	12	2756	12	LP-H1
90N01001	INT-13-120	Interleaf	1	180	13	2756	12	LP-H1





Scan for video

# LP-VM1

## Manual kraft paper dispenser for filling



- Simple design supports quick assembly and easy to load.
- Light weight and small footprint, ensures easy integration into any packaging station.
- Affordable design, low cost.



PN code	Description	Suitable table thickness(inch)	Adjustable height (The paper outlet default is 45°)(inch)	Machine Size Weight (inch)	Machine Weight (LBS)
60A07046	Manual kraft paper dispenser	0.4-3	23-33	16x16x46	17.6

### Kraft Paper Options:

PN code	Model	Paper	Ply	CTN/Pallet	Basis Weight (#)	Length (ft)	Width (inch)
90F01037	MPR-30-150	Recycled	1	60	30	1640	15
90F01045	MPV-30-150	Virgin	1	60	30	1640	15
90F01035	MPE-30-150	Eco	1	60	30	1640	15
90F01032	MPR-43-150	Recycled	1	60	43	1181	15
90F01036	MPV-43-150	Virgin	1	60	43	1181	15
90F01034	MPE-43-150	Eco	1	60	43	1181	15
90F01033	MPR-55-150	Recycled	1	60	55	918	15
90F01043	MPV-55-150	Virgin	1	60	55	918	15
90F01051	MPE-55-150	Eco	1	60	55	918	15

## Handex/FlowFill

### Manual dispenser of wrapping/void fill paper



Scan for video



Handex



FlowFill

The paper is packed in a convenient dispenser box for both portable use and smaller volume applications, making it easy to pull out the desired length of material without a machine.



PN code	Model	Paper Weight (#)	Length (ft)	Width (inch)	Package Size (inch)	Package weight (LBS)
90I01001	Handex(HPS-49-200)	Honeycomb paper: 49	525	20	22x9x9	18
90D01002	FlowFill(BPR-30-150)	Fanfold paper: 30	1640	15	15x11x7	24
90D01001	FlowFill(BPR-43-150)	Fanfold paper: 43	1181	15	15x11x7	24



Scan for video

# EG100

## Electric water-activated tape dispenser



- Superior quality brushes, moistening tape well to enable a strong seal.
- Stainless steel structure and featured durable blade.
- User-friendly design.
- 74OZ large water bottle, support longer continuous work.
- Compact design with a small footprint, saving space.



PN code	Description	Speed inch/s	Cut paper Length (inch)	Tape Width (inch)	Machine Size (inch)	Machine Weight (LBS)
60E01013	Electric water-activated tape dispenser	31.5-43.3	5-118	1-3	17.7x9.4x13	27.5



Scan for video

# MG80

## Manual water-activated tape dispenser



- Designed for personal packaging users with small batch needs.
  - Requires no power and has a small footprint.
- Allowing to start sealing packages anytime, anywhere.

PN code	Description	Bottle Capacity	Tape Width (inch)	Machine Size (inch)	Machine Weight (LBS)
60E01014	Manual water-activated tape dispenser	8.5OZ	1.53	14x5x5	11.5

### Tape Options:

PN code	Model	Weight (#)	Width (inch)	Length (ft)	Reinforcement	Color	Printing	EG100	MG80
90C01003	LP1275-70150-00	78	2.7	492	5	Original	No	√	√
90C01004	LP900-60200-00	55	2.4	656	0	Original	No	√	√
90C01005	LP900-80200-00	55	3.1	656	0	Original	No	√	√
90C01006	LP1274-60200-00	78	2.4	656	0	Original	No	√	√
90C01007	LP1275-80137-00	78	3.1	449	5	Original	No	√	√
90C01008	LP800-80137-00	49	3.1	449	0	Original	No	√	√
90C01009	LP800-60137-00	49	2.4	449	0	Original	No	√	√
90C01012	LP1275-70137-00	78	2.7	449	5	Original	No	√	√
90C01013	LP1274-60200-00	78	2.4	656	4	Original	No	√	√
90C01014	LP1275-80200-00	78	3.1	656	5	Original	No	√	√
90C01015	LP900-60230-00	55	2.4	755	0	Original	No	√	√
90C01016	LP900-80230-00	55	3.1	755	0	Original	No	√	√
90C01017	LP900-40200-00	55	1.6	656	0	Original	No	√	√
90C01018	LP900-40230-00	55	1.6	755	0	Original	No	√	√
90C01019	LP1274-60137-00	78	2.4	449	4	Original	No	√	√
90C01020	LP1275-72200-01	78	2.8	656	5	Original	With	√	√
90C01021	LP805-25137-00	49	1	449	0	Original	No	√	
90C01022	LP1200-70200-00	74	2.7	656	0	Original	No	√	√
90C01023	LP804-60200-01	49	2.4	656	4	Original	With	√	√
90C01024	LP900-60200-01	55	2.4	656	0	Original	With	√	√
90C01025	LP1275-72137-00	78	2.8	449	5	Original	No	√	√
90C01026	LP900-60184-00	55	2.4	604	0	Original	No	√	√
90C01027	LP1273-48137-00	78	1.9	449	3	Original	No	√	√



Sustainable Protective Packaging

**BJT Pack, Inc.**

5275 Naiman Parkway, Suite B  
Solon, Ohio 44139

Phone: +1 440 318 1777

Email: [info@lockedair.com](mailto:info@lockedair.com)